









## 10x20 Modular System (Model# 1020C02) Setup Instruction Sheet

### Step 1: Unpack the Modular from its case. Make sure you have all the parts

Posts x 6		Straight Rail x4		Wrench (9/16) x 1	
Cylinders x 3		Curved Rail x8		Torch x 1	
Bases x 3		Pole Plastic Caps x3		Fabric x 2	

### Step 2: Setting up the Base

- 1) Unscrew the ring and the bolt from the bottom post
- 2) Attach the base. Replace ring and bolt. Tighten with wrench.

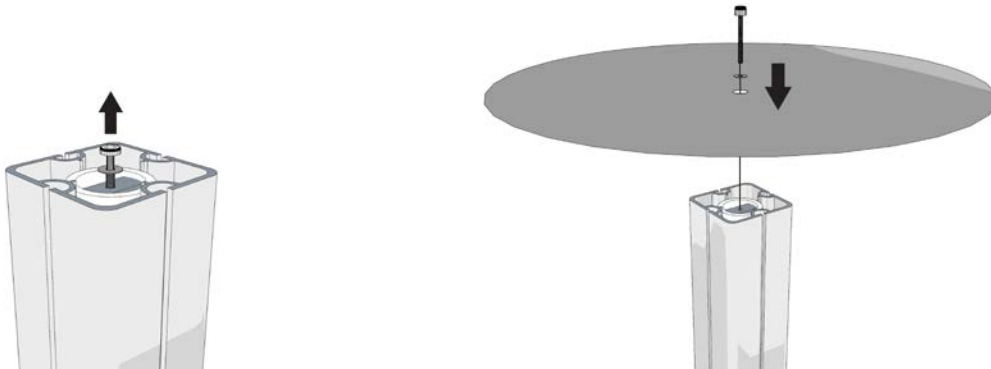

### Step 3: Setting up the top post

- 1) Place plastic cap on top
- 2) Insert the cylinder onto the bottom post
- 3) Slide the top post onto the cylinder.

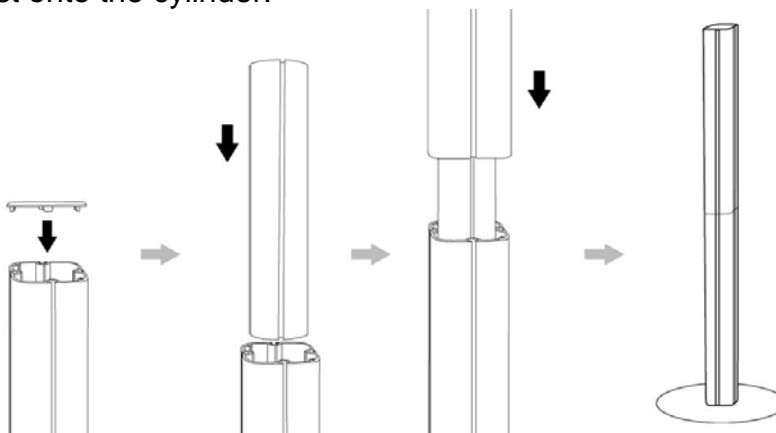

### Step 4: Setting up the Upper Rail

1) Remove the screw from the tongue. Join the 2 curved rails and the straight rail together. Reinsert the screw and tighten it using the torch.

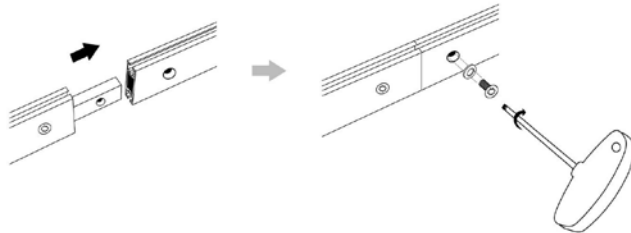

2) Fish the rail into the pocket on the fabric.

*Note: Make sure the trough is on top.*

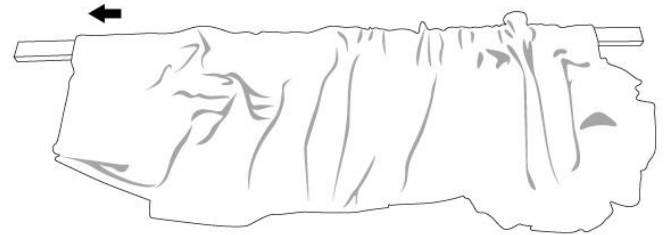

3) Insert the unit into the post. Using the torch, turn 90° clockwise to lock the rails.

4) Attach the other side bar and lock onto the other post.

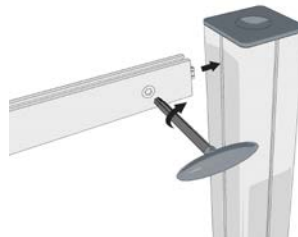

### Step 5: Setting up the Lower Rail

1) Connect the rails together using the above step and string it through the fabric.

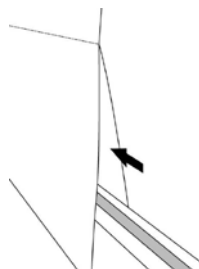

2) Adjust bottom rail to desired height before locking it into place.

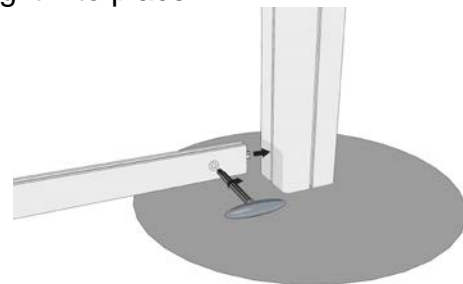

### Step 6: Setting up the lights

1) Sit the lights on top of the fabric and into the troughs on the upper rail. **Make sure the light is sitting securely first!**

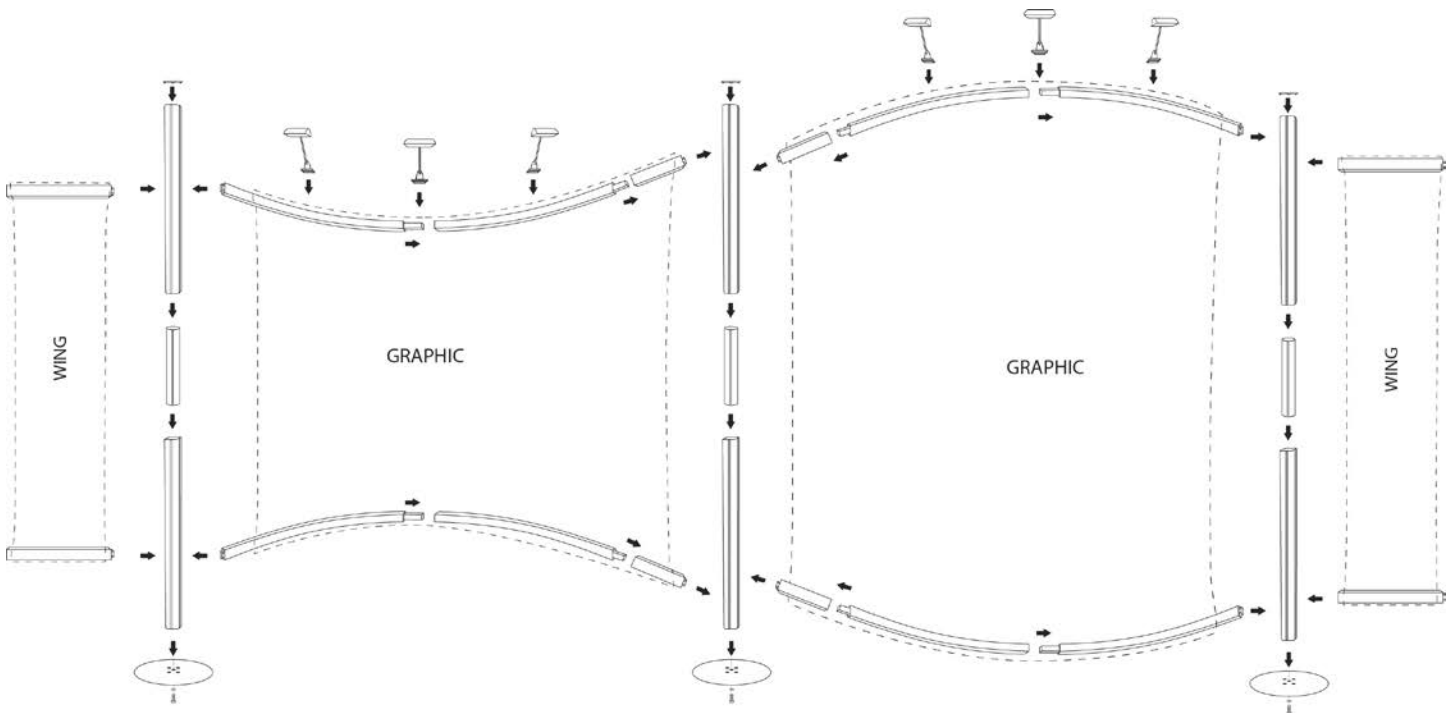
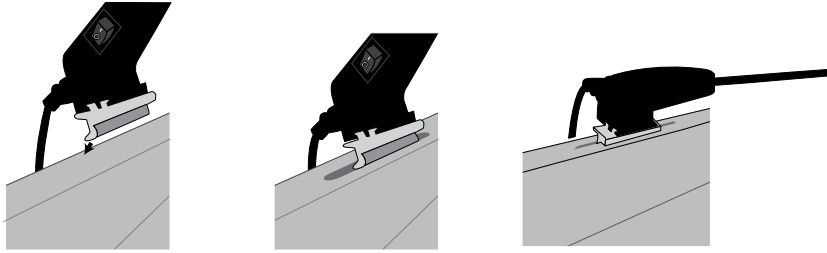

**To Disassemble:** Reverse the Set Up instructions.



**How to wash:** The fabric print can be placed into the washing machine with a small amount of detergent and then dried in the dryer using gentle tumble and low heat settings.